

BLOOM

design by David Grosemans for Sywawa

BLOOM Ø 300 cm - H 240 cm

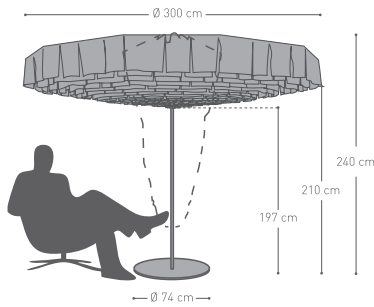



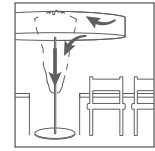
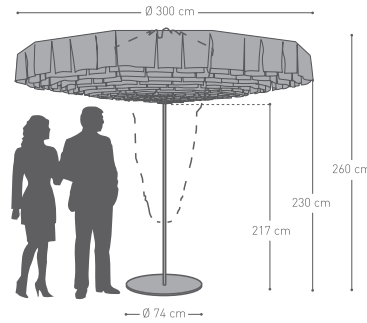









BLOOM Ø 300 cm - H 260 cm



opens easily without hindering tables or guests



PARASOL		VERSION 1 degrade		VERSION 2 coloured top fabric	
FABRIC	top fabric	Polyester with acrylic/teflon coating ±200gr/m ² , highly UV resistant  White		Polyester with acrylic/teflon coating ±200gr/m ² , highly UV resistant     White Yellow Orange Red	
	flags	Polyester  Degrade Red	Polyester  Degrade Black	Polyester  White	
POLE		Ø 40 mm Stainless Steel 316, epoxy primed and powder coated  RED RAL 3027	Ø 40 mm Stainless Steel 316, epoxy primed and powder coated  BLACK RAL 9005	Ø 40 mm - Stainless Steel 316, epoxy primed and powder coated  WHITE RAL 9010	
RIBS		12 x Ø 18mm, Aluminium			
HEIGHT	open=closed	240 cm or 260 cm			
SHADE AREA		±7,07 m ²			
	WEIGHT	30 kg			
	PACKAGING	375 x 40 x 40 cm			
PROTECTIVE COVER		Polyester with acrylic/teflon coating ±200 g/m ² , highly UV-resistant, grey			

This parasol also fits in any standard base that allows parasol poles of Ø 40 mm. The base must have a minimum size of Ø 74 cm and a minimum weight of 42,5 kg. Guarantee only with original Sywawa parts.