

Astro StarWhite

I

Prodotto futuristico, adatto per ambienti moderni e minimalisti. Telaio con finitura effetto StarWhite.

UK

Futuristic product suitable for modern and minimalist settings. The frame has a StarWhite powder-coated finish.

D

Futuristisches Produkt, geeignet für moderne und minimalistische Milieus. Gestell mit StarWhite Effekt.

F

Produit futuriste, adapte aux environnements modernes et minimalistes. Finition structure d'effet StarWhite.

E

Producto futurista, adecuado para ambientes modernos y minimalistas. Estructura acabada efecto StarWhite.



Tech specs

Astro StarWhite / SpaceGray / Carbon

I

MOTION è una soluzione retrattile che permette di aprire o chiudere l'ombrellone vicino al palo, senza rimuovere tavoli e sedie.

La combinazione tra MOTION ed ACTION System permette di aprire o chiudere l'ombrellone in una sola operazione. Grazie alla molla a gas, che compensa il peso del ombrello, il trattamento è molto leggero.

Telaio in alluminio disponibile in versione anodizzato SpaceGray, verniciato a polveri Carbon (antracite) o la nuova finitura StarWhite, bianco opaco. Componenti e viteria in acciaio inox. Accessori in Nylon ABS.

UK

The MOTION system allows the umbrella to retract close to the pole without having to move the furniture beneath it.

Combining the MOTION system with the ACTION system allows the umbrella to open and close with one single movement. The hydraulic gas strut renders the operation very smooth and light.

Aluminium frame available in anodized version SpaceGray or Carbon (anthracite) coated or in the new version StarWhite, matt white. Components and stainless steel hardware. Accessories Nylon ABS.

D

MOTION ist eine einziehbare Lösung und erlaubt, den Sonnenschirm am Mast zu öffnen oder zu schließen, ohne Tisch und Stühle umzuräumen.

Die Kombination von MOTION und ACTION System ermöglicht das Öffnen oder Schließen des Sonnenschirms in einem Arbeitsgang. Dank der Gasfeder, die das Gewicht des Schirmes ausgleicht, ist die Handhabung sehr leicht. Gestell aus Aluminium in eloxierter Ausführung oder pulverbeschichtet Farbe SpaceGray, Carbon (Anthrazit) oder auch in der neuen Version StarWhite, matt Weiss erhältlich. Bestandteile und Schrauben aus Edelstahl. Zubehör aus ABS Nylon.

F

Le système MOTION est une solution rétractable et permet d'ouvrir ou de refermer le parasol sur le mât, sans enlever les tables et les chaises.

La combinaison du MOTION et du système ACTION permet d'ouvrir ou de fermer le parasol en une seule opération. Grâce au ressort à gaz, qui compense le poids du parasol, la manipulation est très légère. Armature disponible en version anodisé SpaceGray avec peinture en poudre couleur Carbon (anthracite) ou dans la nouvelle version StarWhite, blanc opaque. Composants et matériel en acier inoxydable. Accessoires Nylon ABS.

E

The MOTION es una solución retráctil que permite abrir y cerrar el parasol acerca del poste sin quitar mesas y sillas. La combinación entre MOTION y ACTION System permite abrir o cerrar el parasol en una única operación.

Gracias al muelle de gas, que compensa el peso de la sombrilla, el trato es muy ligero. Marco de aluminio disponible en la versión anodizado SpaceGray o pintado en polvo Carbon (antracita) o con nuevo acabado StarWhite, blanco mate. Componentes y herrajes de acero inoxidable. Accesorios en Nylon ABS.

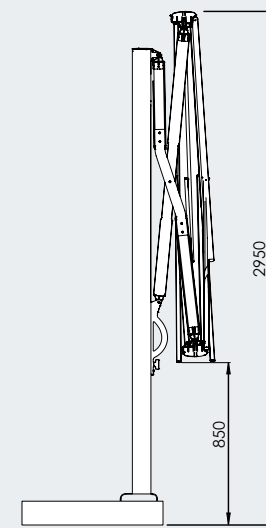
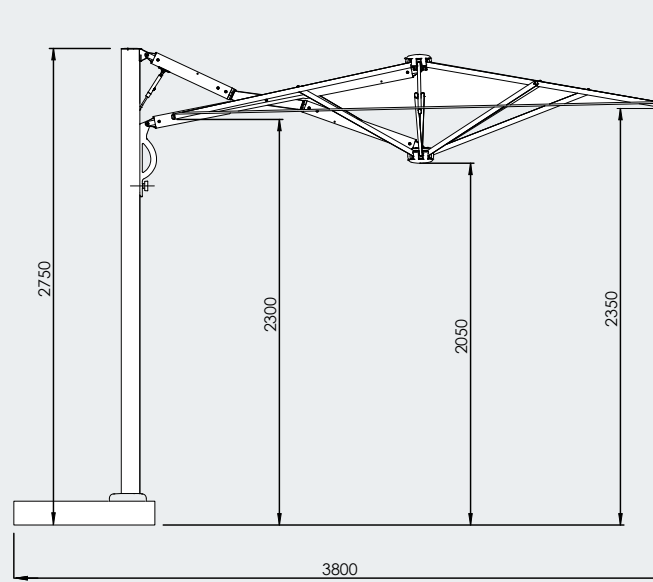
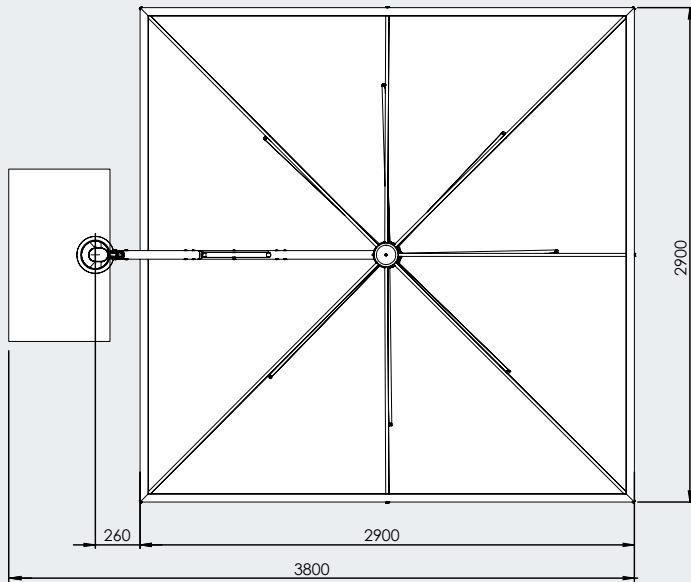

3,0x3,0

Astro StarWhite / SpaceGray / Carbon

CHARACTERISTICS														FINISHING						OPTIONAL			mm	mm	kg					
↑	COD	KG	M ³	↑	↑	↑	↑	↑	↑	360°	↑	↑	↑	↑	↑	↑	↑	↑	↑	↑	↑	↑								
3,0x3,0	STARWHITE C3030 ASW	55	0,45	110x76	STAR WHITE	8	STAR WHITE	18x30	●	●	●	●	●	●	●	●	●	●	●	●	●	●	●							
	CARBON C3030 ASC				CARBON		CARBON																	N°4 BC5151 N°12 BC5050	N°2 BV5050	FISSAGGIO TERRA INGROUND FIX	BC 5151	500X500	110	60
	SPACEGRAY C3030 ASS				SPACE GRAY		SPACE GRAY																				BV5050		270	80

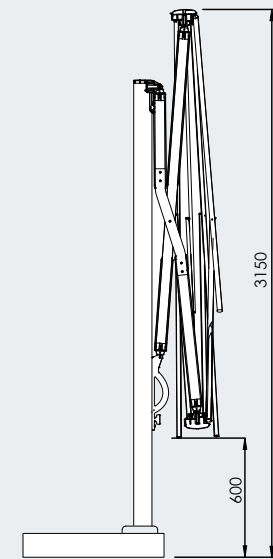
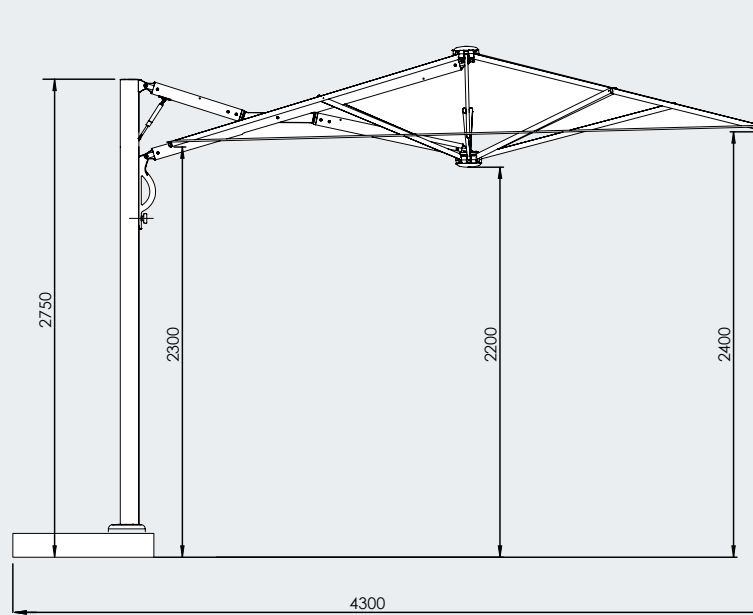
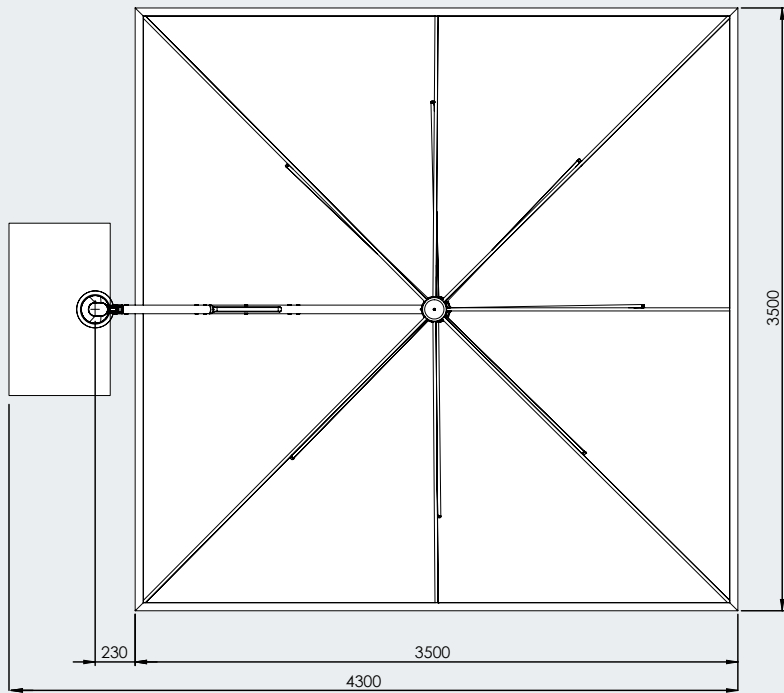

3,5x3,5

Astro StarWhite / SpaceGray / Carbon

CHARACTERISTICS												FINISHING						OPTIONAL			mm	mm	kg											
↑	COD	KG	M ³	↓	↓	↓	↓	↓	↓	360°	↓	↓	↓	↓	↓	↓	↓	↓	↓	↓	↓	↓	↓	↓	↓	↓								
3,5x3,5	STARWHITE C3535 ASW	60	0,45	110x76	STAR WHITE	8	STAR WHITE	18x30	●	●	●	●	●	●	●	●	●	●	●	●	●	●	●	●	●	●	●							
	CARBON C3535 ASC				CARBON		CARBON																					N°4 BC5151 N°12 BC5050	N°2 BV5050	FISSAGGIO TERRA INGROUND FIX	BC 5151	500X500	110	60
	SPACEGRAY C3535 ASS				SPACE GRAY		SPACE GRAY																								BV5050		270	80

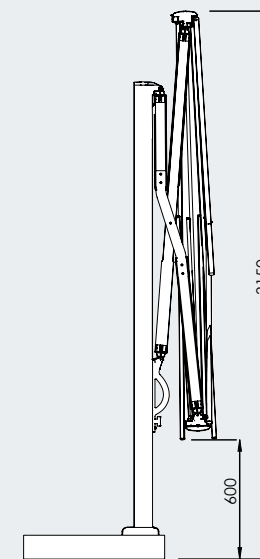
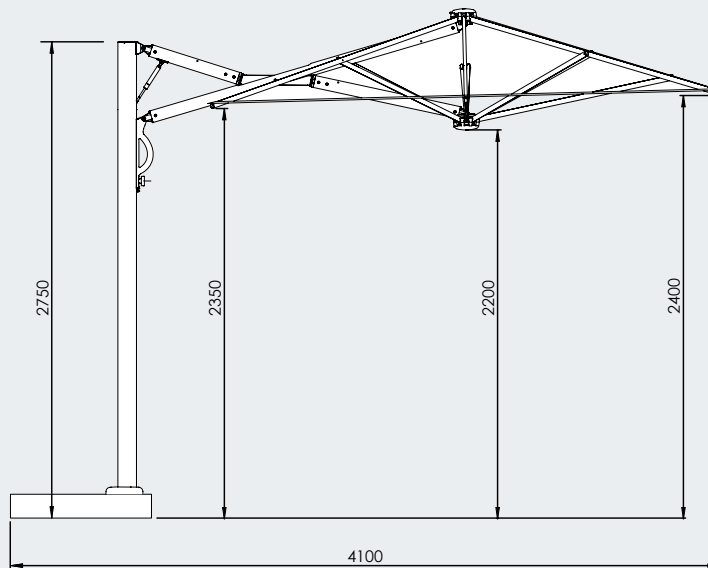
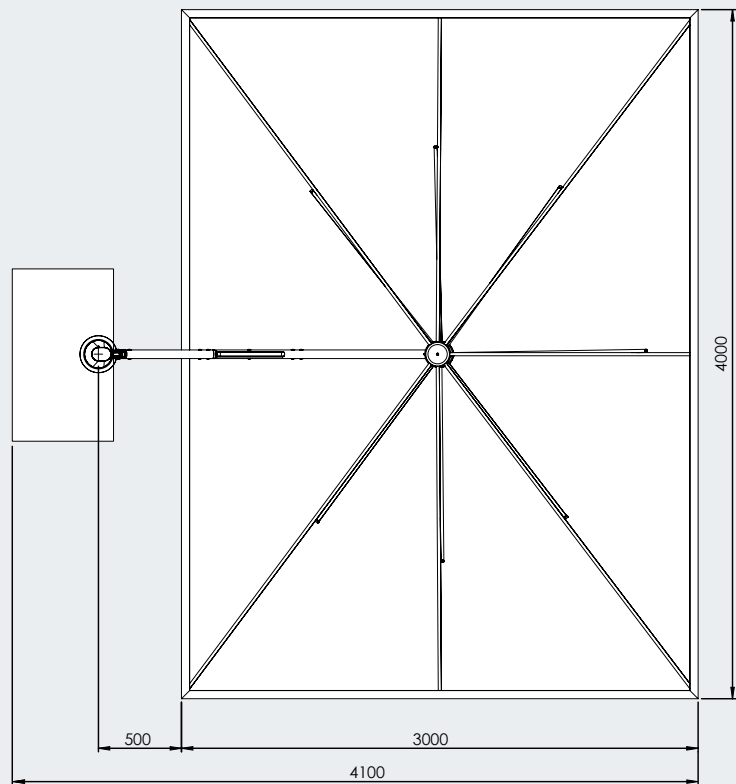

3,0x4,0

Astro StarWhite / SpaceGray / Carbon







CHARACTERISTICS														FINISHING							OPTIONAL			mm	mm	kg
↑	COD	KG	M ³	⌂	🌳	☀️	📦	📏	👤	360°	⚙️	🔪	🔪	📐	INOX	🌳	📏	📏	KG							
3,0x4,0	STARWHITE C3040 ASW	60	0,45	110x76	STAR WHITE	8	STAR WHITE	18x30	●	●	●	●	●	●	●	●	●	N°4 BC5151 N°12 BC5050	N°2 BV5050	FISSAGGIO TERRA INGROUND FIX	BC 5151	500X500	110	60		
	CARBON C3040 ASC				CARBON		CARBON														BV5050		270	80		
	SPACEGRAY C3040 ASS				SPACE GRAY		SPACE GRAY																			

Fabric collection 2018

350 gr/m²

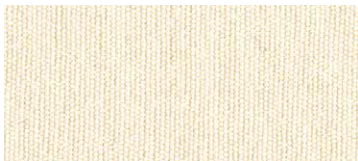
ACRYLIC

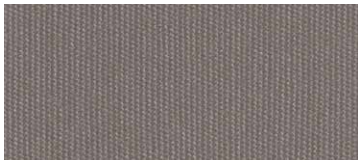

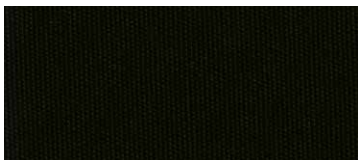
				
	A1 ECRU NATURAL COL. NATUR	70/80%	20/30%	85/89%
	T2 TERRACOTTA ZIEGELROT TERRACOTTA	> 90%	< 10%	100%
	T3 BORDEAUX	> 90%	< 10%	100%
	T6 GRIGIO TAUPE GREY TAUPE GRAU TAUPE GRIS TAUPE GRIJS TAUPE	> 90%	< 10%	100%
	T7 BIANCO WHITE BLANC WEISS	70/80%	20/30%	85/89%
	S1 NERO / BLACK SCHWARZ NOIRE NEGRO ZWART	> 90%	< 10%	100%

I dati forniti, pur essendo frutto di misurazioni scientifiche condotte in laboratori certificati, sono da ritenersi indicativi.

The above mentioned data are indicative, although provided by scientific measurements performed in certified laboratories.

Bases



BC 5151G

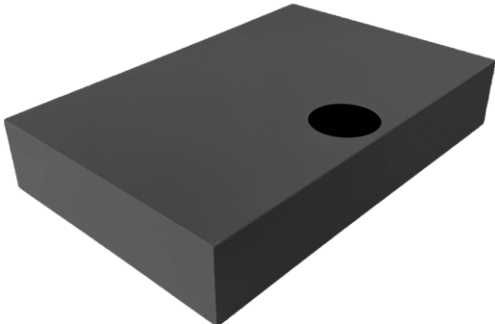

CARTER CARBON
Cod. BCC
ASTRO CARBON



BV5050G



CARTER WHITE
Cod. BCW
ASTRO SPACEGRAY
ASTRO STARWHITE

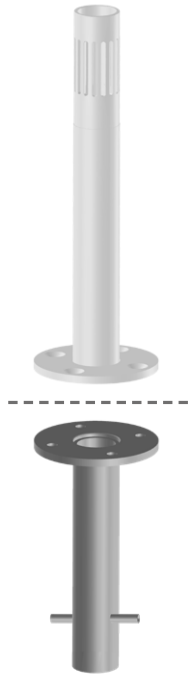

BTA
INGROUND FIX



BV5050B

mm	COD	mm	kg
500X500	BC 5151	110	60
500X500	BC 5151G	110	60
500x500	BV5050G	270	80
500x500	BV5050B	270	80

Materiali e finiture Materials and finishes

Componenti e profili alluminio Aluminium components and profiles



STARWHITE



SPACEGRAY

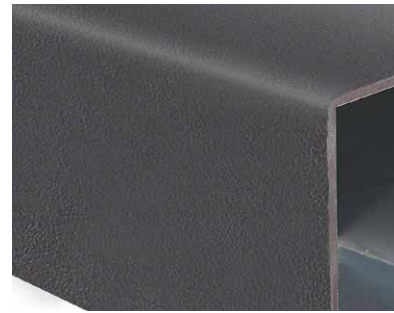

CARBON

Profili stecche Rib profiles



STARWHITE



SPACEGRAY



CARBON



COVER BAG

 .Dimensione (metri)
.Dimensions (meters)
.Masse (Meter)
.Dimensions (metrès)
.Dimensiones (en metros)

 .Fodero
.Cover bag
.Schutzhuelle
.Housse
.Forro

 .Base girevole a 360°C
.Revolving base 360°C
.360°C drehbarer Staender
.Base tournant 360°C
.Base giratoria 360°

 .Codice
.Code
.Artikelcode
.Code
.Código

 .Sistema retrattile
.Retractable system
.Einziehbares System
.Système retractile
.Sistema retráctil

 .Sezione sostegno (mm)
.Support section (mm)
.Mastprofil (mm)
.Section support (mm)
.Sección soporte (mm)

 .Lunghezza
.Length
.Laenge
.Longueur
.Longitud

 .Apertura con molla a gas
.Gas spring opening
.Gasfeder oeffnung
.Ouverture avec ressort à gaz
.Abertura muelle a gas

 .Viteria in inox e ottone nichelato
.Screws in Stainless steel and nickel plated brass
.Edelstahlschrauben und vernickeltes Messing
.Visserie inox et laitton nickelé
.Tornillos en acero inoxidable y bronce niquelado

 .Peso
.Weight
.Gewicht
.Poids
.Peso

 .Con base/supporto
.With base/support
.Mit Staender/Huelse
.Avec base/support
.Con base/ soporte

 .Tipo finitura della struttura/sostegno/componenti
.Finishing for frame/structure/components
.Ausfuehrung des Gestells/der Struktur/der Bestandteile
.Finition armature/structure/composants
.Tipo de acabado de la estructura/Soportes/componente

 .Volume (m3)
.Volume (m3)
.Volumen (m3)
.Volume (m3)
.Volumen (m3)

 .Sezione stecche
.Rib section
.Strebenprofil
.Section baleines
.Sección varillas

 .Colore dei componenti/stecche
.Component/Ribs colour
.Farbe der Bestandteile und Streben
.Couleur des composants et baleines
.Color de los componentes ò piezas/Varillas ò listones

 .Stecche
.Ribs
.Streben
.Baleines
.Varillas

 .Camino antivento
.Wind cap
.Windfang
.Souffle
.Chimenea antiviento

 .Stecca con sistema "easy change"
.Ribs with "easy change" system
.Streben mit "easy change" System
.Baleines avec "easy change" système
.Varillas con sistema de " cambio fácil"

 .Massima Stabilità Ottenibile
.Maximum Obtainable Stability
.Maximal Erhaeltliche Stabilitaet
.Maximum De Stabilité Realisable
.Maxima Estabilidad Posible

 .Peso consigliato in condizioni normali
.Recommended weight in normal condition
.Empfohlenes gewicht unter normalen bedingungen
.Poids recommande dans des conditions normales
.Peso recomendado en condiciones normales

 .Peso minimo richiesto
.Minimum ballast required
.Erforderliches mindestgewicht
.Poids minimum requis
.Peso minimo requerido